

September 9, 2014
Revised February 4, 2016
File No. 14-206

Mr. Haolin Zheng
Run Yong USA
c/o Mr. Jim Dearth
Ripple Design Studio, Inc.
4214 Stone Way N, Seattle, WA 98103

**Subject: Geotechnical Report - Revised
Proposed Development
8375 and 8383 East Mercer Way, Mercer Island, WA**

Dear Mr. Zheng,

As requested, PanGEO, Inc. has completed a geotechnical engineering study for the proposed development at the above-referenced properties. This study was performed in general accordance with our mutually agreed scope of work outlined in our proposal dated July 7, 2014, and was subsequently approved by you on July 20, 2014. Our service scope included reviewing readily-available geologic and geotechnical data in the project vicinity, reviewing preliminary layout plans, drilling four test borings, conducting a site reconnaissance, performing geotechnical engineering analysis, and developing the conclusions and preliminary recommendations presented in this report.

SITE AND PROJECT DESCRIPTION

The subject site consists of two adjoining single-family residential lots located at the south end of Mercer Island with addresses of 8375 and 8383 East Mercer Way (see Vicinity Map, Figure 1). Each lot is currently occupied by a two-story single-family dwelling. The two lots have a combined area of about 51,000 square feet (see Figure 2). The subject lots are bordered approximately east by East Mercer Way, and by existing single-family residences on other three sides. Based on review of the topographic survey completed at the site, the site grade generally slopes down from west to east with an average gradient of approximately 15 to 20 percent.

However, steep slopes (40% or greater) are present along the eastern edge of the site, adjacent to East Mercer Way.

We understand the existing buildings will be demolished and the two properties will be subdivided into three single-family residential lots (see Figure 2). Detailed design of the single-family residence are not available at the time this report was prepared. However, we understand that the proposed single-family residences will be wood frame, three-story structures with attached garages. Based on the preliminary information provided to us, site grading for the proposed development will likely include fill and cuts up to 7 to 8 feet for the driveway and building foundation construction.

According to the City of Mercer Island, the subject property contains several mapped geologic hazards, including steep slopes, potential landslide, seismic, and erosion hazards. As such, a geotechnical report will be required as part of the permit application to subdivide the property.

The conclusions and recommendations in this report are based on our understanding of the proposed development, which is in turn based on the project information provided. If the above project description is incorrect, or the project information changes, we should be consulted to review the recommendations contained in this study and make modifications, if needed.

SUBSURFACE EXPLORATIONS

Four borings (BH-1 through BH-4) were drilled at the site on August 28 and 29, 2014, using a hand-operated portable drill rig owned and operated by CN Drilling of Seattle, Washington. The approximate boring locations were taped in the field from on-site features and are shown on Figure 2. The borings were drilled to depths of about 14 to 31½ feet.

The drill rig was equipped with 4-inch outside diameter hollow stem augers. Soil samples were obtained from the borings at 2½-foot depth intervals in general accordance with Standard Penetration Test (SPT) sampling methods (ASTM test method D-1586) in which the samples are obtained using a 2-inch outside diameter split-spoon sampler. The sampler was driven into the soil a distance of 18 inches using a 140-pound weight freely falling a distance of 30 inches. The number of blows required for each 6-inch increment of sampler penetration was recorded. The number of blows required to achieve the last 12 inches of sample penetration is defined as the SPT N-value. The N-value provides an empirical measure of the relative density of cohesionless soil, or the relative consistency of fine-grained soils.

A geologist from PanGEO was present to observe the drilling, assist in sampling, and to describe and document the soil samples obtained from the borings. The soil samples were described and field classified in general accordance with the symbols and terms outlined in Figure A-1, and the summary boring logs are included as Figures A-2 through A-5.

SITE GEOLOGY AND SUBSURFACE CONDITIONS

SITE GEOLOGY

According to the Geologic Map of Mercer Island (Troost and Wisher, 2006), the site is underlain by Advance Outwash (Qva) and Lawton Clay (Qvlc). Advance Outwash (Qva) deposits are described by Troost, et al. as dense, well-sorted sand and gravel deposited by streams issuing from advancing ice sheet. Lawton Lay (Qvlc) typically consists of very stiff to hard, laminated to massive, silt, clayey silt, and silty clay that deposited in Puget Lowland proglacial lakes.

SUBSURFACE AND GROUNDWATER CONDITIONS

The soils encountered in the borings are interpreted as Disturbed Outwash Sand and Advance Outwash deposits. The following is a description of the soils encountered in the test borings advanced at the site. Please refer to the boring summary logs (Figures A-2 through A-5) for a detailed description of the conditions encountered at each boring location.

UNIT 1: Disturbed Outwash Sand – Very loose to medium dense, sand to silty sand with occasional gravel were encountered in all borings. Based on the blow-counts and structure of the soil samples, we interpret this unit to be Disturbed Outwash Sand deposits. This unit extended to about 28 feet in BH-1, and to the bottom of BH-2 through BH-4 at about 14 to 26½ feet below the surface.

UNIT 2: Advance Outwash Deposits – In boring BH-1, dense, gray, fine to medium sand was encountered from about 27½ to the bottom of boring at 31½ feet. This unit appears to be consistent with the mapped Advance Outwash deposit.

Groundwater was encountered at about 5 feet in BH-2 during drilling, corresponding to an elevation of 173 feet. The groundwater was encountered between 12½ and 25 feet in BH-1, BH-3, and BH-4, corresponding to elevations of about 151½ to 157 feet. The shallow groundwater table in BH-2 may be influenced by the water in a nearby pond. It should be noted that groundwater elevations and seepage rates are likely to vary depending on the season, local

subsurface conditions, and other factors. Groundwater levels and seepage rates are normally highest during the winter and early spring.

GEOLOGY HAZARDS ASSESSMENT

LANDSLIDE HAZARDS AND STEEP SLOPES

The subject site is mapped within a potential landslide hazard area according to the City of Mercer Island's Geologic Hazards Map. A site reconnaissance of the subject property was conducted on August 28 and 29, 2014. During our site reconnaissance, we did not observe obvious evidence of past landslides at the site. Based on our field observations, the general topography at the site and vicinity, and the results of our subsurface explorations, in our opinion, the subject site appears to be globally stable in its current configuration. However, based on the subsurface conditions encountered and site topography, it appears that the factor of safety for long-term slope stability of the site slopes may not meet the code requirements. As such, additional slope stability analyses will need to be performed in the final design stage to evaluate the long-term site stability. If adequate factors of safety cannot be obtained for the final site configurations, site stabilization or mitigations will be required. In our opinion, a soldier pile wall near the east property line or slope stabilization, including but limited to aggregate piers, cannot be ruled out. PanGEO will provide stabilization/mitigation recommendations after additional analyses are conducted in the final design stage, if needed.

SEISMIC HAZARDS

Based on our review of the City of Mercer Island's Geologic Hazards Maps, the subject site is mapped within a seismic hazard area. The City of Mercer Island Code defines seismic hazard areas as those areas subject to risk of damage as a result of earthquake-induced ground shaking, slope failure, and soil liquefaction or surface faulting.

Based on the soil conditions encountered, it is our opinion that the loose to medium dense sand below the groundwater table at the site has a moderate potential for soil liquefaction during an IBC-code level earthquake. Potential effects of soil liquefaction include ground settlement and seismic slope instability. The estimated settlement due to soil liquefaction for IBC-code event is estimated to be on the order of 2 to 3 inches.

To mitigate the slope instability during and post IBC-code level earthquake, the site will need to be improved and stabilized. Based on the site conditions and our understanding of the project design, it is our opinion that soil improvement using aggregate piers appears to be appropriate for the proposed project. Our recommendations for the soil improvement are presented in the “Soil Improvement” section of this report.

EROSION HAZARDS

The subject site is mapped within a potential erosion hazard area according to the City of Mercer Island’s Geologic Hazards Map. Based on soil conditions encountered in the borings, the near-surface site soils are likely to exhibit moderate to high erosion potential. In our opinion, the erosion hazards at the site can be effectively mitigated with the best management practice during construction and with properly designed and implemented landscaping for permanent erosion control. During construction, the temporary erosion hazard can be effectively managed with an appropriate erosion and sediment control plan, including but not limited to installing silt fence at the construction perimeter, limiting removal of vegetation to the construction area, placing rocks or hay bales at the disturbed/traffic areas and on the downhill side of the project, covering stockpile soil or cut slopes with plastic sheets, constructing a temporary drainage pond to control surface runoff and sediment trap, placing quarry spalls at the construction entrance, etc. Permanent erosion control measures should include establishing vegetation, landscape plants, and hardscape established at the end of project, and reducing surface runoff to the minimum extent possible.

GEOTECHNICAL DESIGN RECOMMENDATIONS

SOIL IMPROVEMENT (AGGREGATE PIERS)

As previously discussed, the site soil needs to be improved to mitigate the risks of seismic slope instability during a strong earthquake. In our opinion, a feasible soil improvement technique consists of improving the upper 25 feet of soil with aggregate piers installed by a qualified ground improvement contractor. The aggregate pier system consists of compacting columns of well-graded stone, typically spaced 5 to 6 feet, to increase the density of poor soils, to mitigate liquefaction potential of the treated soils, to reduce settlements during static and seismic conditions, and to increase the slope stability during an earthquake. Because the aggregate pier elements increase the stiffness of the subsurface soils, and provide additional drainage pathways

for excess pore water pressure during a seismic event, the potential for earthquake induced liquefaction in the improved soils is reduced.

We performed slope stability analysis using the computer program *Slide v6.0* (Rocscience, 2010) to evaluate the slope stability of improved soil. Based on our analysis, it is our opinion that a minimum 40-foot wide zone of site soil across the site in north-south direction will needed to be improved to achieve the required factors of safety against the potential slope failure during and post a strong earthquake. Based on the current design, it is our opinion that a 40-foot wide zone along the two east buildings appears most appropriate (see Figure 2). The soil and material parameters used in our slope stability analysis are summarized in the Table 1 below.

Table 1 – Soil Parameters for Slope Stability Analysis

Material Type		Unit Weight (pcf)	Cohesion (psf)	Friction Angles (degrees)
Unit 1	Loose to medium dense sand	110	0	29
	Liquefied Soil	100	250	0
Unit 2 – Medium dense to dense sand		120	0	33
Unit 3 – Aggregate Pier Improved Soil		125	0	34

The seismic stability was analyzed using pseudo-static procedures, where the effect of earthquake ground shaking is represented by the use of a “seismic coefficient” in the stability calculations. In our pseudo-static stability analysis, one-half of the expected peak ground acceleration, or 0.292g, was used.

The results of our post-construction slope analyses are also summarized on Figures 3 through 5, for static and pseudo-static conditions for both sections. Based on the results of the analysis, it is our opinion that the post soil improvement site conditions has adequate factors of safety against potential failures under static and seismic conditions.

Conventional spread footings or mat foundations founded directly on the improved soil may be used to support the proposed buildings. The foundations areas of the two east buildings outside of the 40-foot zone should be also be improved with aggregate piers. Aggregate piers should extend at least 25 feet below the existing surface. The aggregate pier system should be designed

by the contractor to determine allowable bearing pressures, improved soil characteristics and anticipated settlements and, specifically, is responsible for the foundation system design. As a minimum, the aggregated pier improved soil mass should have a composite soil friction of 34 degree to satisfy the slope stability requirements. The aggregate pier improved soil should also be able to provide an allowable bearing pressure of 3,000 psf for the footing design.

SEISMIC DESIGN PARAMETERS

The Table 1 on page 6 provides seismic design parameters for the site that are in conformance with the 2012 edition of the International Building Code (IBC), which specifies a design earthquake having a 2% probability of occurrence in 50 years (return interval of 2,475 years), and the 2008 USGS seismic hazard maps:

Table 2 – Seismic Design Parameters

Site Class	Spectral Acceleration at 0.2 sec. (g)	Spectral Acceleration at 1.0 sec. (g)	Site Coefficients		Design Spectral Response Parameters	
	S _s	S ₁	F _a	F _v	S _{DS}	S _{DI}
D	1.461	0.556	1.00	1.50	0.974	0.556

BUILDING FOUNDATIONS

As previously indicated, it is our opinion that either a mat foundation or a conventional footing system on aggregate piers may be used to support the two east buildings. The west building can either be supported on shallow footings on aggregate piers or small diameter steel pipes (pin piles). The performance of conventional footings on aggregate piers may be improved by tying the individual footings together with concrete grade beams. The following sections present our recommendations for the shallow footings and pin piles.

Shallow Footings

Design Bearing Pressure – For shallow footings on the aggregate piers, we recommend that an allowable soil bearing pressure of 3,000 pounds per square feet (psf) be used for sizing the footings. The recommended allowable bearing pressure is for dead plus live loads. For allowable stress design, the recommended bearing pressure may be increased by one-third for

transient loading, such as wind or seismic forces. Continuous and individual spread footings should have minimum widths of 18 and 24 inches, respectively.

Footing Embedment – Exterior foundation elements should be placed at a minimum depth of 18 inches below final exterior grade. Interior spread foundations should be placed at a minimum depth of 12 inches below the top of slab.

Lateral Resistance – Lateral loads on the structures may be resisted by passive earth pressure developed against the embedded portion of the foundation system and by frictional resistance between the bottom of the foundation and the supporting subgrade soils. For footings bearing on the dense native till or structural fill, a frictional coefficient of 0.35 may be used to evaluate sliding resistance developed between the concrete and the compacted subgrade soil. Passive soil resistance may be calculated using an equivalent fluid weight of 300 pcf, assuming properly compacted structural fill will be placed against the footings. The above values include a factor of safety of 1.5. Unless covered by pavements or slabs, the passive resistance in the upper 12 inches of soil should be neglected.

Foundation Performance – Footings designed and constructed in accordance with the above recommendations should experience total settlement of less than one inch and differential settlement of less than ½ inch. Most of the anticipated settlement should occur during construction as dead loads are applied.

Perimeter Footing Drain – Footing drains should be installed around the perimeter of the building, at or just below the invert of the footings. Under no circumstances should roof downspout drain lines be connected to the footing drain systems. Roof downspouts must be separately tightlined to appropriate discharge locations. Cleanouts should be installed at strategic locations to allow for periodic maintenance of the footing drain and downspout tightline systems.

Footing Subgrade Preparation – The footing subgrade should be in a dense condition prior to form setting and rebar placement. The adequacy of footing subgrade should be verified by a representative of PanGEO, prior to placing forms or rebar.

Driven Small Diameter Steel Pipe Piles (Pin Piles)

Alternatively, the west building may be supported on pin piles, in-lieu of shallow footings on the aggregate piers. The pin pile foundations should consist of 3- or 4-inch diameter, Schedule 40,

galvanized, steel pipes. Allowable axial compression capacities of 6 and 10 tons may be used for the 3- and 4-inch diameter pin piles, respectively. Tensile capacity of the pin piles should be ignored. Penetration resistance required to achieve the capacities will be determined based on the hammer used as discussed in the following sections.

The required pile length to develop the recommended pile capacity is expected to vary based on the boring data. For planning and cost estimating purposes, it is our opinion that an average pile length of about 20 to 30 feet may be assumed.

Pile splices may be made with compression fitted sleeve pipe couplers (see Typical Splicing Detail on page 10). Splicing using welding of pipe joints should not be used, as welds will typically be broken during driving.

Three- or 4-inch diameter piles are typically installed using small (approximately 650 to 1,100 pound) hammers mounted to a small excavator. The criterion for driving refusal is defined as the minimum amount of time (in seconds) required to achieve one inch of penetration, and it varies with the size of hammer used for pile driving. For 3- or 4-inch pin piles, the following is a summary of driving refusal criteria for different hammer sizes that are commonly used:

Table 3 - Summary of Commonly-Accepted Driving Criteria for a 3- or 4-inch Pipe with a 6- or 10-ton Allowable Axial Compression Load

Hammer Model	Hammer Weight (lb) / Blows per minute	3" Pile Refusal Criteria (seconds per inch of penetration)	4" Pile Refusal Criteria (seconds per inch of penetration)
Hydraulic TB 225	650 / 550 - 1100	12	20
Hydraulic TB 325	850 / 550 - 1100	10	16
Hydraulic TB 425	1,100 / 550 - 1100	6	10

Please note that these refusal criteria were established empirically based on previous load tests on 3- and 4-inch pin piles. Contractors may select a different hammer for driving these piles, and propose a different driving criterion. In this case, it is the contractor's responsibility to

demonstrate to the Engineer's satisfaction that the design load can be achieved based on their selected equipment and driving criteria.

The quality of a pin pile foundation is dependent in part on the experience and professionalism of the installation company. Therefore, a qualified contractor with pin pile driving experience on similar projects should be selected to install the piles. We recommend that the following specifications be included on the foundation plan:

1. All piles shall consist of galvanized Schedule-40, ASTM A-53 Grade "A" pipe.
2. 3- or 4-inch pin piles shall be driven to refusal as shown in Table 2 above.
3. Piles shall be driven in nominal sections and connected with compression fitted sleeve couplers (see detail below – Courtesy of McDowell Pile King, Kent, WA).
4. The geotechnical engineer of record or his/her representative shall provide observation of pile installation and testing to verify the driving refusal criteria.

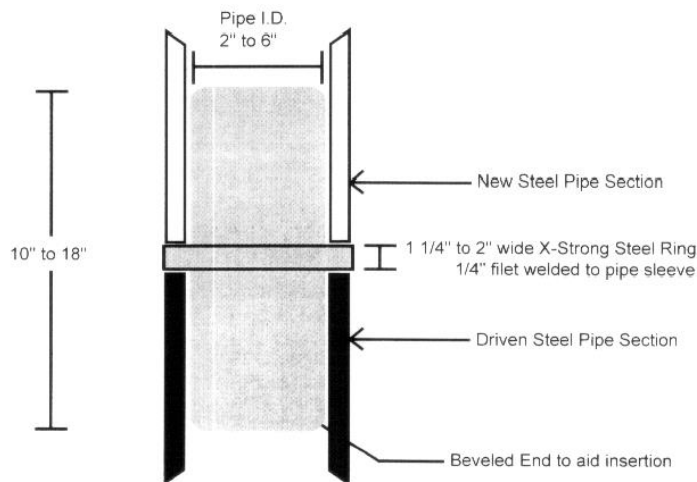

Typical Splicing Detail

Lateral Forces - The capacity of pin pipes to resist lateral loads is very limited and should not be used in design. Therefore, lateral forces from wind or seismic loading should be resisted by the passive earth pressures acting against the pile caps and below-grade walls or from battered piles (batter no steeper than 3(H):12(V)). **Friction at the base of pile-supported concrete grade beam should be ignored in the design calculations.** Passive resistance values may be determined using an equivalent fluid weight of 300 pounds per cubic foot (pcf). This value includes a safety

factor of about 1.5 assuming that properly compacted granular fill will be placed adjacent to and surrounding the pile caps and grade beams.

FLOORS SLABS

The floor slabs for the proposed buildings may be constructed using conventional concrete slab-on-grade floors construction. The floor slabs may be supported on recompacted native sandy soil or structural fill placed on properly compacted on-site sandy soil. Organic-rich soil or loose soil that cannot be compacted to a dense condition at the slab subgrade level should be over-excavated and replaced with compacted structural fill.

Interior concrete slab-on-grade floors should be underlain by at least of 4 inches capillary break. The capillary break material should be clean crushed rocks that have no more than 10 percent passing the No. 4 sieve and less than 5 percent by weight of the material passing the U.S. Standard No. 100 sieve. The capillary break should be placed on the subgrade that has been compacted to a dense and unyielding condition. A 10-mil polyethylene vapor barrier should also be placed directly below the slab. We also recommend that construction joints be incorporated into the floor slab to control cracking.

RETAINING AND BASEMENT WALL DESIGN PARAMETERS

Retaining and basement walls should be properly designed to resist the lateral earth pressures exerted by the soils behind the wall. Proper drainage provisions should also be provided behind the walls to intercept and remove groundwater that may be present behind the wall. Our geotechnical recommendations for the design and construction of the retaining/basement walls are presented below.

Lateral Earth Pressures

Concrete cantilever walls should be designed for an equivalent fluid pressure of 35 pcf for level backfills behind the walls assuming the walls are free to rotate. If walls are to be restrained at the top from free movement, such as below-grade building walls, equivalent fluid pressures of 45 pcf should be used for level backfills behind the walls. Walls with a maximum 2H:1V backslope should be designed for an active and at rest earth pressure of 45 and 55 pcf, respectively.

Permanent walls should be designed for an additional uniform lateral pressure of 7H psf for seismic loading, where H corresponds to the buried depth of the wall. The recommended lateral

pressures assume that the backfill behind the wall consists of a free draining and properly compacted fill with adequate drainage provisions.

Surcharge

Surcharge loads, where present, should also be included in the design of retaining walls. We recommend that a lateral load coefficient of 0.3 be used to compute the lateral pressure on the wall face resulting from surcharge loads located within a horizontal distance of one-half wall height.

Lateral Resistance

Lateral forces from seismic loading and unbalanced lateral earth pressures may be resisted by a combination of passive earth pressures acting against the embedded portions of the foundations and by friction acting on the base of the foundations. Passive resistance values may be determined using an equivalent fluid weight of 300 pcf. This value includes a factor of safety of 1.5, assuming the footing is poured against dense native sand, re-compacted on-site sandy soil or properly compacted structural fill adjacent to the sides of footing. A friction coefficient of 0.35 may be used to determine the frictional resistance at the base of the footings. The coefficient includes a factor safety of 1.5.

Wall Drainage

Provisions for wall drainage should consist of a 4-inch diameter perforated drainpipe behind and at the base of the wall footings, embedded in 12 to 18 inches of clean crushed rock and pea gravel wrapped with a layer of filter fabric. A minimum 18-inch wide zone of free draining granular soils (i.e. pea gravel or washed rock) is recommended to be placed adjacent to the wall for the full height of the wall. Alternatively, a composite drainage material, such as Miradrain 6000, may be used in lieu of the clean crushed rock or pea gravel. The drainpipe at the base of the wall should be graded to direct water to a suitable outlet.

The exterior of all basement walls should be protected with a damp proofing compound. We also recommend the designers consider utilizing a waterproofing material, such as prefabricated clay mats, on the exterior of all below grade walls to reduce the potential for moisture intrusion into the below-grade portion of the building.

Wall Backfill

In our opinion, the relatively clean on-site sandy soil may be re-used as wall backfill. Imported wall backfill, if needed, should consist of granular material, such as WSDOT Gravel Borrow or approved equivalent. In areas where the space is limited between the wall and the face of excavation, pea gravel or clean crushed rock may be used as backfill without compaction.

Wall backfill should be moisture conditioned to within about 3 percent of optimum moisture content, placed in loose, horizontal lifts less than 8 inches in thickness, and systematically compacted to a dense and relatively unyielding condition and to at least 95 percent of the maximum dry density, as determined using test method ASTM D 1557. Within 5 feet of the wall, the backfill should be compacted with hand-operated equipment to at least 90 percent of the maximum dry density.

CONSTRUCTION CONSIDERATIONS

SITE PREPARATION

Site preparation for the proposed project mainly includes removing the existing buildings, site clearing and excavations to the design subgrade. All debris resulted from demolition and site clearing should be hauled away from the site. The stripped surface materials should be properly disposed off-site or be “wasted” on site in non-structural landscaping areas.

Following site clearing and excavations, the adequacy of the subgrade where structural fill, foundations, slabs, or pavements are to be placed should be verified by a representative of PanGEO. The subgrade soil in the improvement areas, if recompacted and still yielding, may need to be over-excavated and replaced with compacted structural fill or lean-mix concrete. The need for overexcavation should be determined by PanGEO.

TEMPORARY EXCAVATIONS

As currently planned, the proposed development may require excavations up to about 7 to 8 feet deep for the driveway and building construction. The deepest excavation will occur at the southwest corner of the building. We anticipate the excavations to mainly encounter loose to very dense sand with variable amounts of silt and gravel (colluvium and Pre-Olympia Deposits). All temporary excavations should be performed in accordance with Part N of WAC (Washington

Administrative Code) 296-155. The contractor is responsible for maintaining safe excavation slopes and/or shoring.

All temporary excavations with a total overall depth greater than 4 feet should be sloped or shored. Based on the soil conditions at the site, for planning purposes, it is our opinion that temporary excavations for the proposed construction may be sloped 1H:1V or flatter.

The temporary excavations and cut slopes should be re-evaluated in the field during construction based on actual observed soil conditions, and may need to be modified in the wet seasons. The cut slopes should be covered with plastic sheets in the raining season. We also recommend that heavy construction equipment, building materials, excavated soil, and vehicular traffic should not be allowed within a distance equal to 1/3 the slope height from the top of any excavation.

MATERIAL REUSE

In the context of this report, structural fill is defined as compacted fill placed under footings, concrete stairs and landings, and slabs, or other load-bearing areas. In our opinion, the on-site sand is poorly graded and is not suitable as structural fill, but may be used as general fill in the non-structural and landscaping areas. Structural fill should consist of imported, well-graded, granular material, such as WSDOT Gravel Borrow (WSDOT 9-03.14(1)) or approved equivalent. Well-graded recycled concrete may also be considered as a source of structural fill. Use of recycled concrete as structural fill should be approved by the geotechnical engineer. If use of the on-site soil is planned, the excavated soil should be stockpiled and protected with plastic sheeting to prevent softening from rainfall in the wet season.

STRUCTURAL FILL PLACEMENT AND COMPACTION

Structural fill should be moisture conditioned to within about 3 percent of optimum moisture content, placed in loose, horizontal lifts less than 8 inches in thickness, and systematically compacted to a dense and relatively unyielding condition and to at least 95 percent of the maximum dry density, as determined using test method ASTM D 1557.

Depending on the type of compaction equipment used and depending on the type of fill material, it may be necessary to decrease the thickness of each lift in order to achieve adequate compaction. PanGEO can provide additional recommendations regarding structural fill and compaction during construction.

WET WEATHER EARTHWORK

In our opinion, the proposed site construction may be accomplished during wet weather (such as in winter) without adversely affecting the site stability. However, earthwork construction performed during the drier summer months likely will be more economical. Winter construction will require the implementation of best management erosion and sedimentation control practices to reduce the risk of off-site sediment transport. Most of the site soils within the anticipated depth of excavation contain a high percentage of fines and are moisture sensitive. Any footing subgrade soils that become softened either by disturbance or rainfall should be removed and replaced with structural fill, Controlled Density Fill (CDF), or lean-mix concrete. General recommendations relative to earthwork performed in wet conditions are presented below:

- Site stripping, excavation and subgrade preparation should be followed promptly by the placement and compaction of clean structural fill or CDF;
- The size and type of construction equipment used may have to be limited to prevent soil disturbance;
- The ground surface within the construction area should be graded to promote run-off of surface water and to prevent the ponding of water;
- Geotextile silt fences should be strategically located to control erosion and the movement of soil;
- Structural fill should consist of less than 5% fines; and
- Excavation slopes should be covered with plastic sheets.

SURFACE DRAINAGE CONSIDERATIONS

Surface runoff can be controlled during construction by careful grading practices. Typically, this includes the construction of shallow, upgrade perimeter ditches or low earthen berms in conjunction with silt fences to collect runoff and prevent water from entering excavations or to prevent runoff from the construction area from leaving the immediate work site.

Permanent control of surface water should be incorporated in the final grading design. Adequate surface gradients and drainage systems should be incorporated into the design such that surface runoff is directed away from slopes and structures. Water from roof drains and other impervious

areas should be properly collected and discharged into a storm drain system, and should not be discharged on to the slope areas.

ADDITIONAL SERVICES

To confirm that our recommendations are properly incorporated into the design and construction of the proposed residence, PanGEO should be retained to conduct a review of the final project plans and specifications, and to monitor the construction of geotechnical elements. The City of Mercer Island, as part of the permitting process, will also require geotechnical construction inspection services. PanGEO can provide you a cost estimate for construction monitoring services at a later date.

We anticipate that the following additional services will be required:

- Review final project plans and specifications
- Verify implementation of erosion control measures;
- Verify adequacy of footing subgrade;
- Monitor temporary excavation;
- Verify the adequacy of subsurface drainage installation;
- Confirm the adequacy of the compaction of structural backfill; and
- Other consultation as may be required during construction

Modifications to our recommendations presented in this report may be necessary, based on the actual conditions encountered during construction.

CLOSURE

We have prepared this report for Run Yong USA and the project design team. Recommendations contained in this report are based on a site reconnaissance, a subsurface exploration program, review of pertinent subsurface information, and our understanding of the project. The study was performed using a mutually agreed-upon scope of work.

Variations in soil conditions may exist between the locations of the explorations and the actual conditions underlying the site. The nature and extent of soil variations may not be evident until construction occurs. If any soil conditions are encountered at the site that are different from those described in this report, we should be notified immediately to review the applicability of our recommendations. Additionally, we should also be notified to review the applicability of our recommendations if there are any changes in the project scope.

The scope of our work does not include services related to construction safety precautions. Our recommendations are not intended to direct the contractors' methods, techniques, sequences or procedures, except as specifically described in our report for consideration in design. Additionally, the scope of our work specifically excludes the assessment of environmental characteristics, particularly those involving hazardous substances. We are not mold consultants nor are our recommendations to be interpreted as being preventative of mold development. A mold specialist should be consulted for all mold-related issues.

This report has been prepared for planning and design purposes for specific application to the proposed project in accordance with the generally accepted standards of local practice at the time this report was written. No warranty, express or implied, is made.

This report may be used only by the client and for the purposes stated, within a reasonable time from its issuance. Land use, site conditions (both off and on-site), or other factors including advances in our understanding of applied science, may change over time and could materially affect our findings. Therefore, this report should not be relied upon after 24 months from its issuance. PanGEO should be notified if the project is delayed by more than 24 months from the date of this report so that we may review the applicability of our conclusions considering the time lapse.

It is the client's responsibility to see that all parties to this project, including the designer, contractor, subcontractors, etc., are made aware of this report in its entirety. The use of information contained in this report for bidding purposes should be done at the contractor's option and risk. Any party other than the client who wishes to use this report shall notify PanGEO of such intended use and for permission to copy this report. Based on the intended use of the report, PanGEO may require that additional work be performed and that an updated report be reissued. Noncompliance with any of these requirements will release PanGEO from any liability resulting from the use this report.

We appreciate the opportunity to be of service.

Sincerely,



Michael H. Xue, P.E.
Senior Geotechnical Engineer

A handwritten signature in blue ink, appearing to read "Siew L. Tan", is positioned to the right of the seal.

Siew L. Tan, P.E.
Principal Geotechnical Engineer

Enclosures:

- Figure 1 Vicinity Map
- Figure 2 Site and Exploration Plan
- Figure 3 Summary of Slope Stability Analysis – Post-construction – Static
- Figure 4 Summary of Slope Stability Analysis – Post-construction – Seismic
- Figure 5 Summary of Slope Stability Analysis – Post-construction – Post Liquefaction

Appendix A Summary Boring Logs

- Figure A-1 Terms and Symbols for Boring and Test Pit Logs
- Figure A-2 Log of Test Boring BH-1
- Figure A-3 Log of Test Boring BH-2
- Figure A-4 Log of Test Boring BH-3
- Figure A-5 Log of Test Boring BH-4

REFERENCES

International Code Council, 2012, *International Building Code (IBC)*.

Troost, K.G., and Wisler, A. P, 2006. *Geologic Map of Mercer Island, Washington, scale 1:24,000*.

WSDOT, 2014, *Standard Specifications for Road, Bridge and Municipal Construction, M 41-10*.

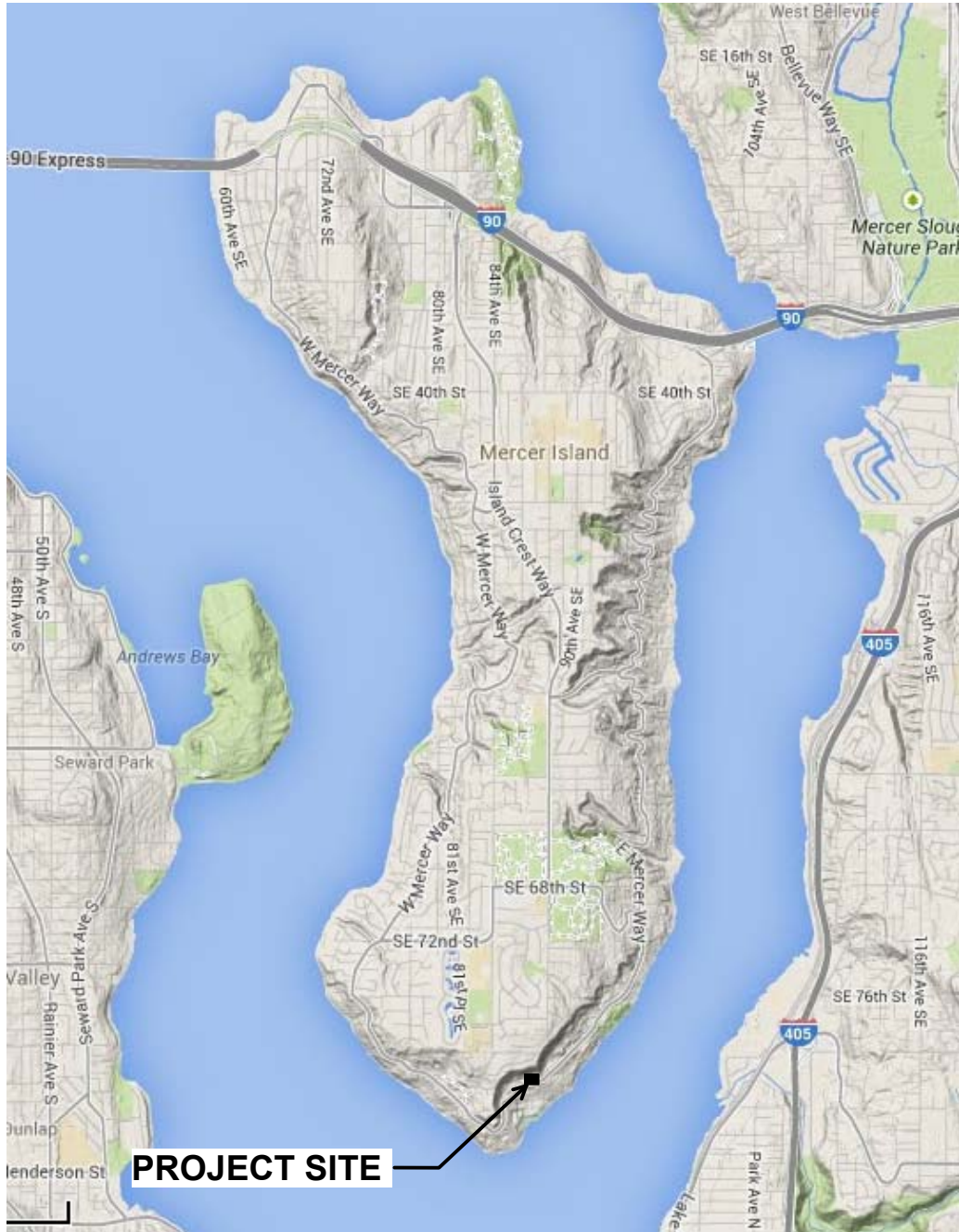

Not to Scale

Base Map: Google Maps



Proposed Development
8375 & 8383 E Mercer Way
Mercer Island, WA

VICINITY MAP

Project No. **14-206**

Figure No. **1**

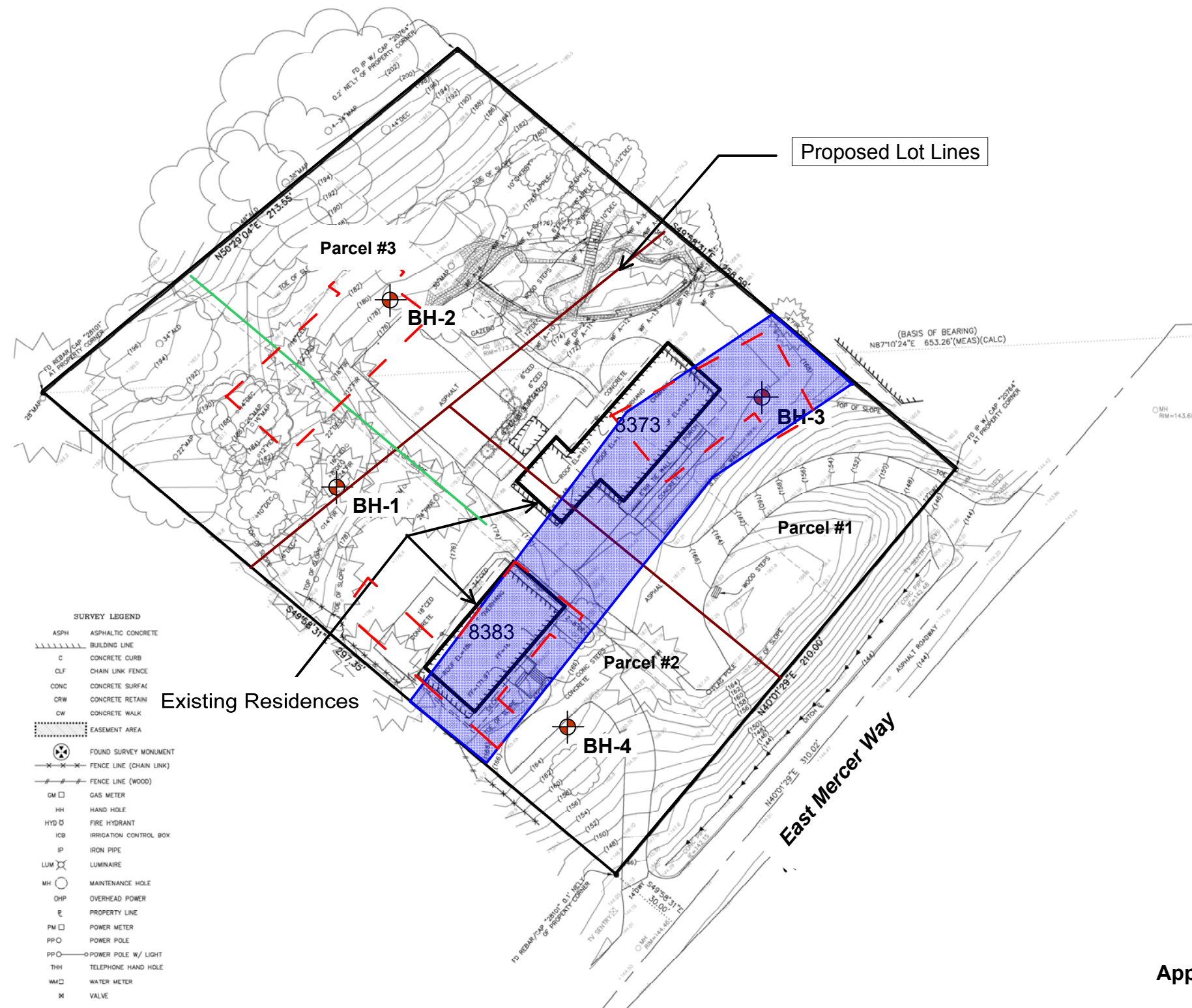

Legend:

BH-1 PanGEO Boring

Proposed Residences

Recommended Aggregate Pier Area

- SURVEY LEGEND**
- ASPH ASPHALTIC CONCRETE
 - BLD BUILDING LINE
 - C CONCRETE CURB
 - CLF CHAIN LINK FENCE
 - CONC CONCRETE SURFAC
 - CRW CONCRETE RETAIN
 - CW CONCRETE WALK
 - EASEMENT AREA
 - FOUND SURVEY MONUMENT
 - FENCE LINE (CHAIN LINK)
 - FENCE LINE (WOOD)
 - GM GAS METER
 - HH HAND HOLE
 - HYD FIRE HYDRANT
 - ICB IRRIGATION CONTROL BOX
 - IP IRON PIPE
 - LUM LUMINAIRE
 - MH MAINTENANCE HOLE
 - DHP OVERHEAD POWER
 - P PROPERTY LINE
 - PM POWER METER
 - PP POWER POLE
 - PP POWER POLE W/ LIGHT
 - TH TELEPHONE HAND HOLE
 - WM WATER METER
 - V VALVE

Note: Site Plan modified from Topographic Survey by GeoDimentions, dated 8/25/2014.

	Proposed Development 8375 & 8383 E Mercer Way Mercer Island, Washington	SITE AND EXPLORATION PLAN	
		Project No. 14-206	Figure No. 2

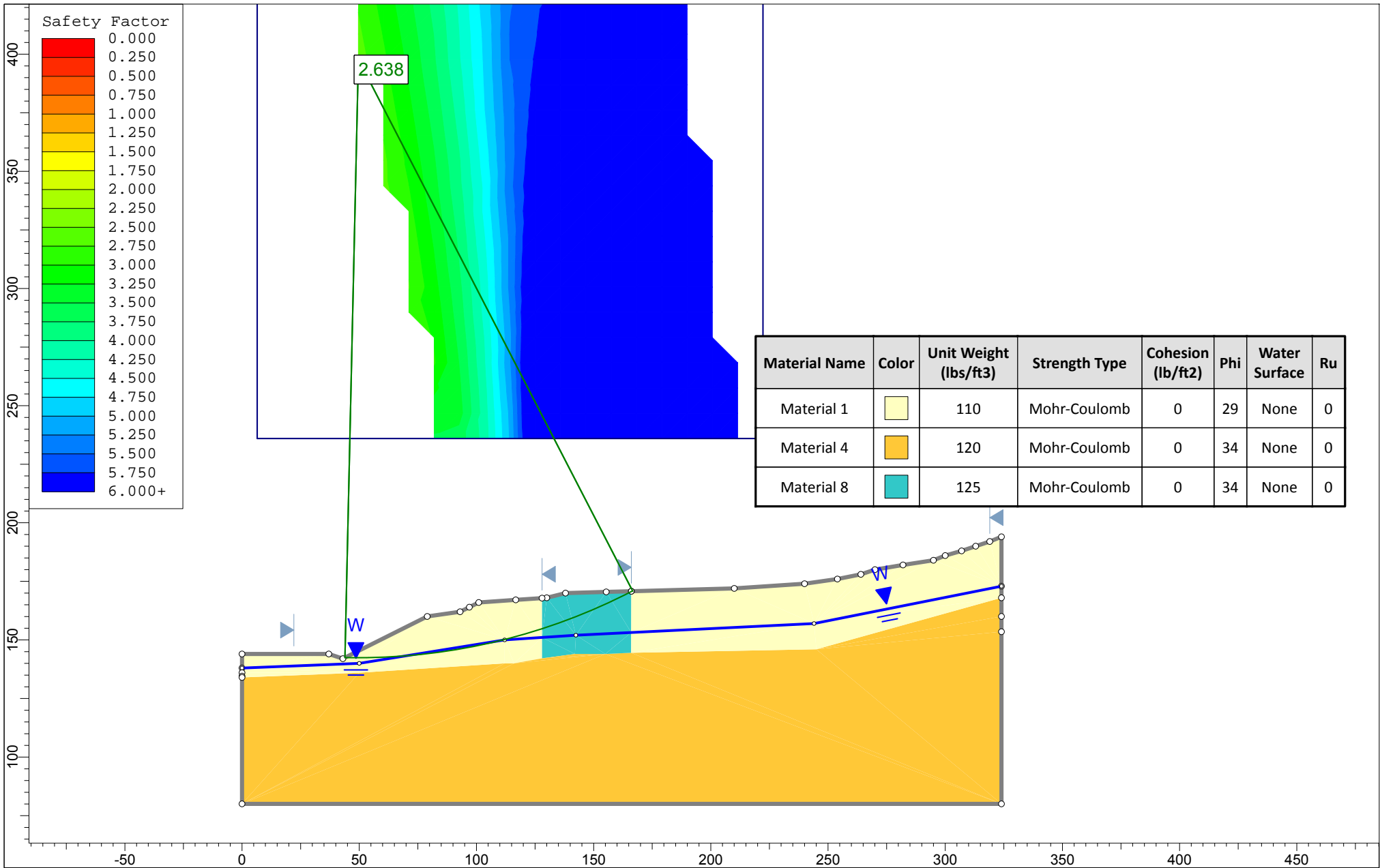

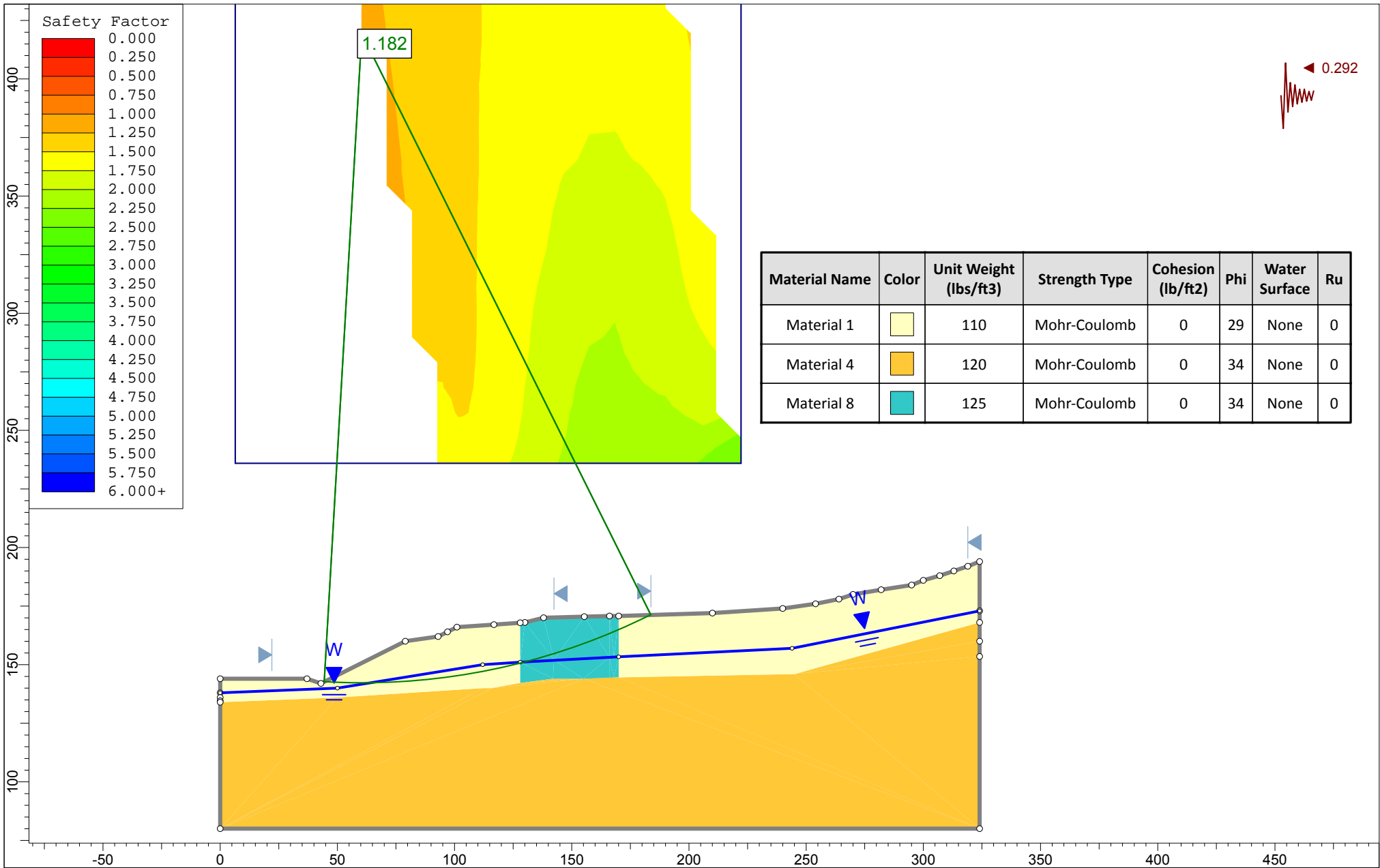

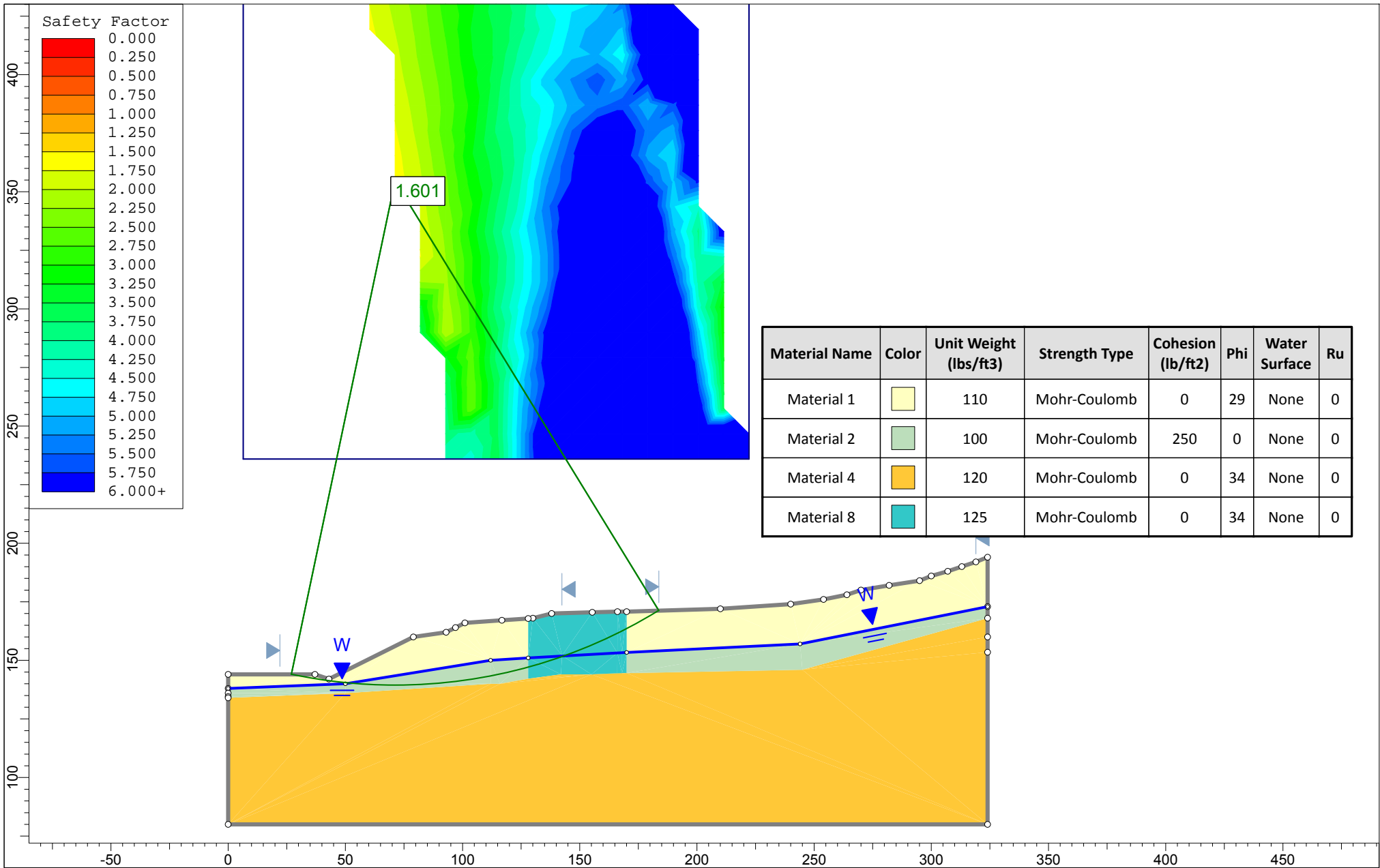

APPENDIX A

SUMMARY TEST BORING LOGS

RELATIVE DENSITY / CONSISTENCY

SAND / GRAVEL			SILT / CLAY		
Density	SPT N-values	Approx. Relative Density (%)	Consistency	SPT N-values	Approx. Undrained Shear Strength (psf)
Very Loose	<4	<15	Very Soft	<2	<250
Loose	4 to 10	15 - 35	Soft	2 to 4	250 - 500
Med. Dense	10 to 30	35 - 65	Med. Stiff	4 to 8	500 - 1000
Dense	30 to 50	65 - 85	Stiff	8 to 15	1000 - 2000
Very Dense	>50	85 - 100	Very Stiff	15 to 30	2000 - 4000
			Hard	>30	>4000

UNIFIED SOIL CLASSIFICATION SYSTEM

MAJOR DIVISIONS		GROUP DESCRIPTIONS	
Gravel 50% or more of the coarse fraction retained on the #4 sieve. Use dual symbols (eg. GP-GM) for 5% to 12% fines.	GRAVEL (<5% fines)		GW: Well-graded GRAVEL
	GRAVEL (>12% fines)		GP: Poorly-graded GRAVEL
			GM: Silty GRAVEL
Sand 50% or more of the coarse fraction passing the #4 sieve. Use dual symbols (eg. SP-SM) for 5% to 12% fines.	SAND (<5% fines)		GC: Clayey GRAVEL
	SAND (>12% fines)		SW: Well-graded SAND
			SP: Poorly-graded SAND
			SM: Silty SAND
Silt and Clay 50% or more passing #200 sieve	Liquid Limit < 50		SC: Clayey SAND
			ML: SILT
	Liquid Limit > 50		CL: Lean CLAY
			OL: Organic SILT or CLAY
			MH: Elastic SILT
			CH: Fat CLAY
Highly Organic Soils		OH: Organic SILT or CLAY	
		PT: PEAT	

TEST SYMBOLS

for In Situ and Laboratory Tests listed in "Other Tests" column.

- ATT Atterberg Limit Test
- Comp Compaction Tests
- Con Consolidation
- DD Dry Density
- DS Direct Shear
- %F Fines Content
- GS Grain Size
- Perm Permeability
- PP Pocket Penetrometer
- R R-value
- SG Specific Gravity
- TV Torvane
- TXC Triaxial Compression
- UCC Unconfined Compression

SYMBOLS

Sample/In Situ test types and intervals

- 2-inch OD Split Spoon, SPT (140-lb. hammer, 30" drop)
- 3.25-inch OD Split Spoon (300-lb hammer, 30" drop)
- Non-standard penetration test (see boring log for details)
- Thin wall (Shelby) tube
- Grab
- Rock core
- Vane Shear

- Notes:**
- Soil exploration logs contain material descriptions based on visual observation and field tests using a system modified from the Uniform Soil Classification System (USCS). Where necessary laboratory tests have been conducted (as noted in the "Other Tests" column), unit descriptions may include a classification. Please refer to the discussions in the report text for a more complete description of the subsurface conditions.
 - The graphic symbols given above are not inclusive of all symbols that may appear on the borehole logs. Other symbols may be used where field observations indicated mixed soil constituents or dual constituent materials.

DESCRIPTIONS OF SOIL STRUCTURES

Layered: Units of material distinguished by color and/or composition from material units above and below	Fissured: Breaks along defined planes
Laminated: Layers of soil typically 0.05 to 1mm thick, max. 1 cm	Slickensided: Fracture planes that are polished or glossy
Lens: Layer of soil that pinches out laterally	Blocky: Angular soil lumps that resist breakdown
Interlayered: Alternating layers of differing soil material	Disrupted: Soil that is broken and mixed
Pocket: Erratic, discontinuous deposit of limited extent	Scattered: Less than one per foot
Homogeneous: Soil with uniform color and composition throughout	Numerous: More than one per foot
	BCN: Angle between bedding plane and a plane normal to core axis

COMPONENT DEFINITIONS

COMPONENT	SIZE / SIEVE RANGE	COMPONENT	SIZE / SIEVE RANGE
Boulder:	> 12 inches	Sand	
Cobbles:	3 to 12 inches	Coarse Sand:	#4 to #10 sieve (4.5 to 2.0 mm)
Gravel		Medium Sand:	#10 to #40 sieve (2.0 to 0.42 mm)
Coarse Gravel:	3 to 3/4 inches	Fine Sand:	#40 to #200 sieve (0.42 to 0.074 mm)
Fine Gravel:	3/4 inches to #4 sieve	Silt	0.074 to 0.002 mm
		Clay	<0.002 mm

MONITORING WELL

- Groundwater Level at time of drilling (ATD)
- Static Groundwater Level
- Cement / Concrete Seal
- Bentonite grout / seal
- Silica sand backfill
- Slotted tip
- Slough
- Bottom of Boring

MOISTURE CONTENT

Dry	Dusty, dry to the touch
Moist	Damp but no visible water
Wet	Visible free water

LOG KEY 13-104 LOGS.GPJ_PANGEO.GDT 6/18/13

Project: 8375 & 8383 E Mercer Way Job Number: 14-206 Location: Mercer Island, Washington Coordinates: Northing: , Easting:	Surface Elevation: 182.0ft Top of Casing Elev.: Drilling Method: Hollow Stem Auger Sampling Method: SPT
---	--

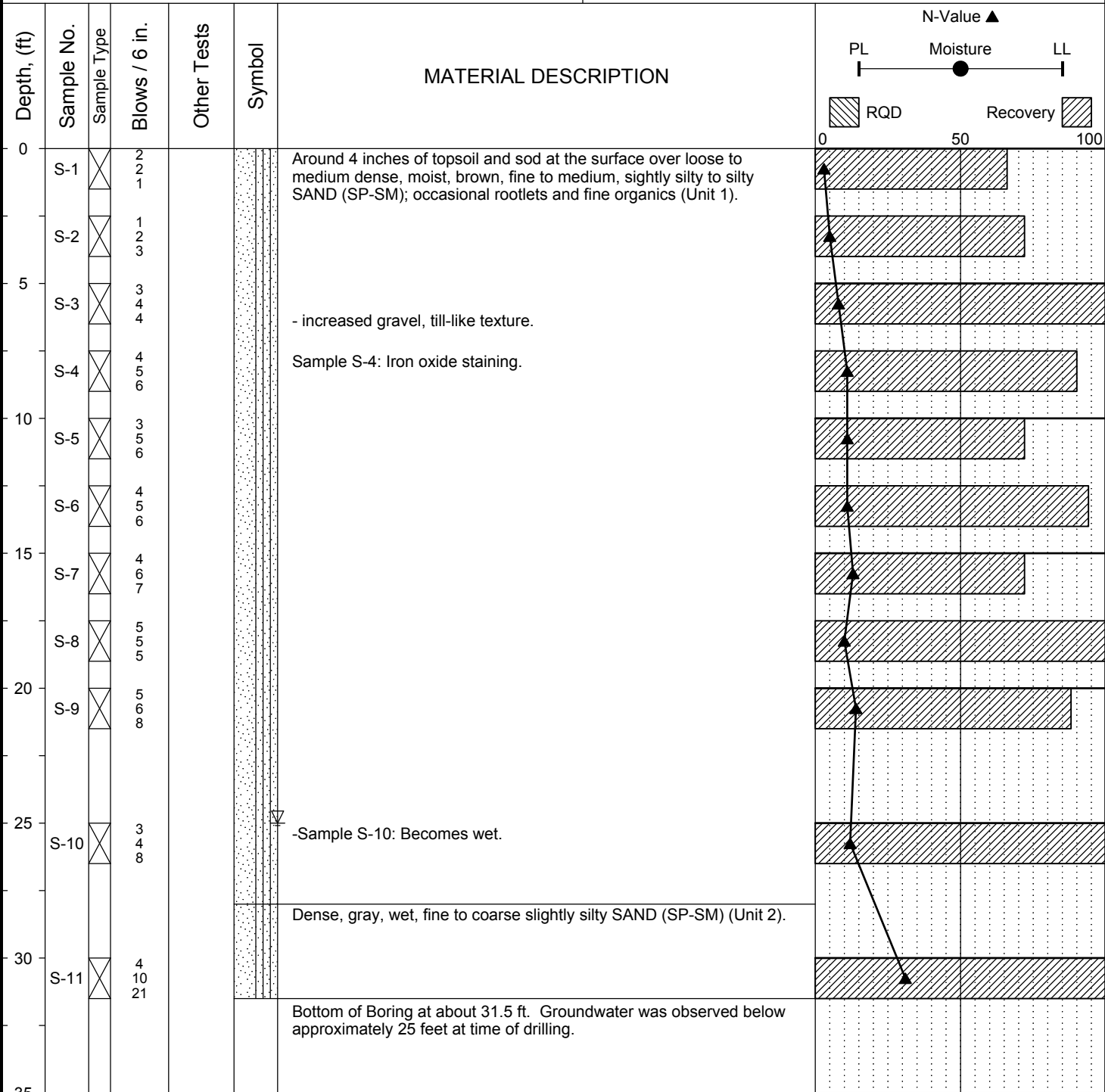

Completion Depth: 31.5ft Date Borehole Started: 8/28/14 Date Borehole Completed: 8/28/14 Logged By: NER Drilling Company: CN Drilling, Inc.	Remarks: Acker Portable Drill. Standard Penetration Test (SPT) sampler driven with a 140 lb. hammer. Hammer operated with a rope and cathead mechanism. Elevation data based on site survey by GeoDimensions, Inc.
---	--

Project:	8375 & 8383 E Mercer Way	Surface Elevation:	178.0ft
Job Number:	14-206	Top of Casing Elev.:	
Location:	Mercer Island, Washington	Drilling Method:	Hollow Stem Auger
Coordinates:	Northing: , Easting:	Sampling Method:	SPT

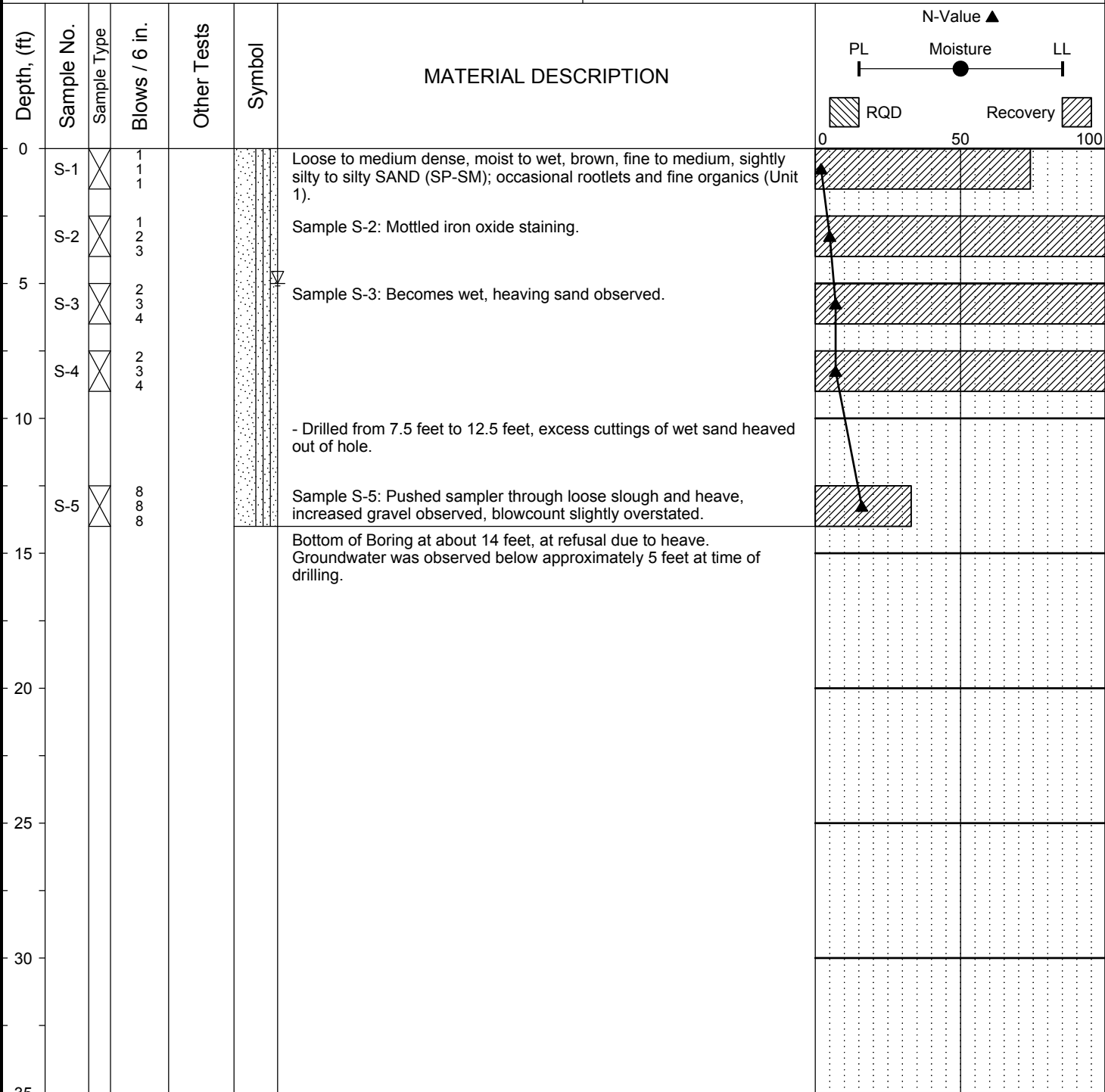

Completion Depth:	14.0ft	Remarks: Acker Portable Drill. Standard Penetration Test (SPT) sampler driven with a 140 lb. hammer. Hammer operated with a rope and cathead mechanism. Elevation data based on site survey by GeoDimensions, Inc.
Date Borehole Started:	8/28/14	
Date Borehole Completed:	8/28/14	
Logged By:	NER	
Drilling Company:	CN Drilling, Inc.	

Project: 8375 & 8383 E Mercer Way Job Number: 14-206 Location: Mercer Island, Washington Coordinates: Northing: , Easting:	Surface Elevation: 170.0ft Top of Casing Elev.: Drilling Method: Hollow Stem Auger Sampling Method: SPT
---	--

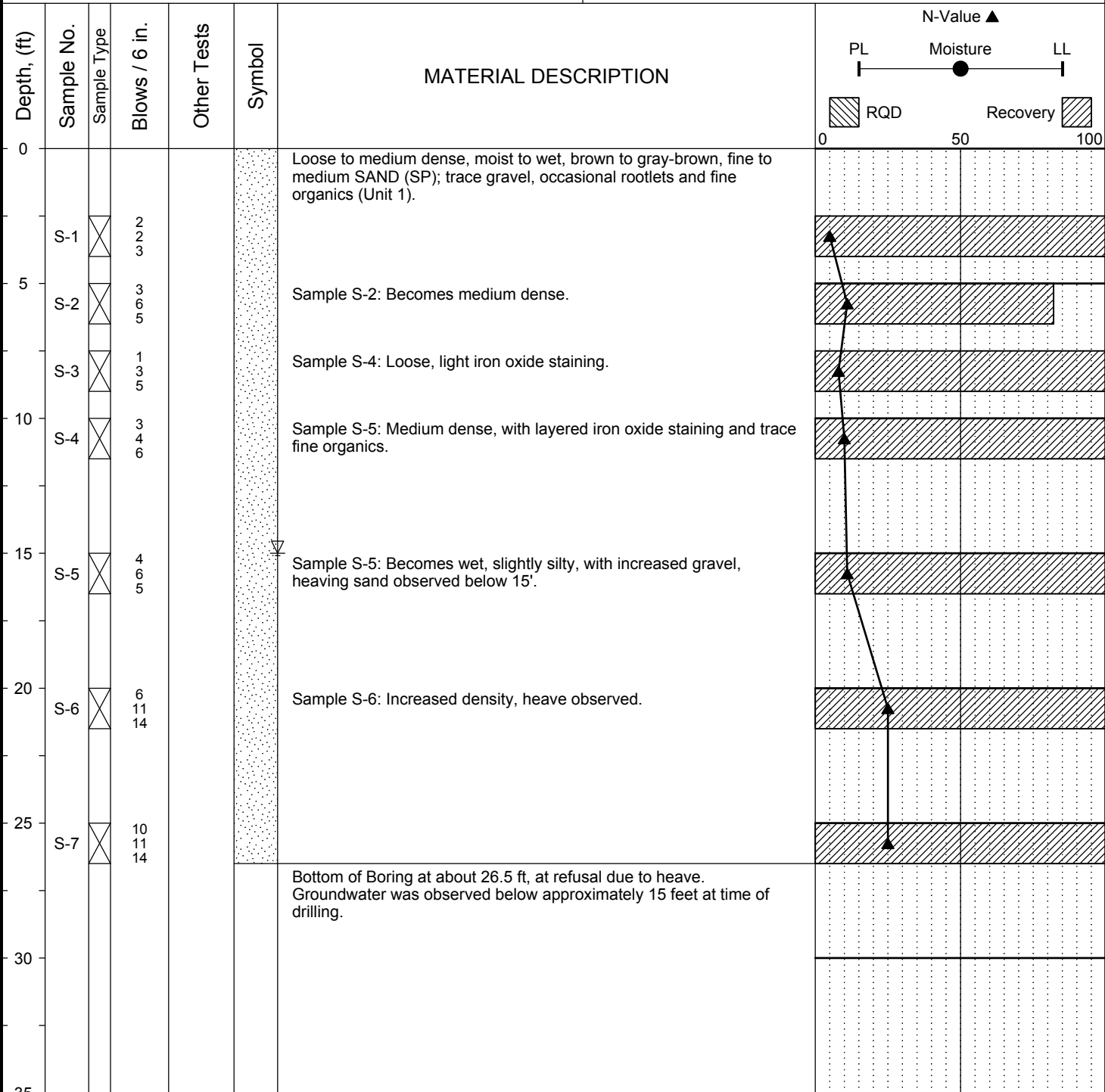

Completion Depth: 26.5ft Date Borehole Started: 8/28/14 Date Borehole Completed: 8/29/14 Logged By: NER Drilling Company: CN Drilling, Inc.	Remarks: Acker Portable Drill. Standard Penetration Test (SPT) sampler driven with a 140 lb. hammer. Hammer operated with a rope and cathead mechanism. Elevation data based on site survey by GeoDimensions, Inc.
---	--

Project: 8375 & 8383 E Mercer Way	Surface Elevation: 164.0ft
Job Number: 14-206	Top of Casing Elev.:
Location: Mercer Island, Washington	Drilling Method: Hollow Stem Auger
Coordinates: Northing: , Easting:	Sampling Method: SPT

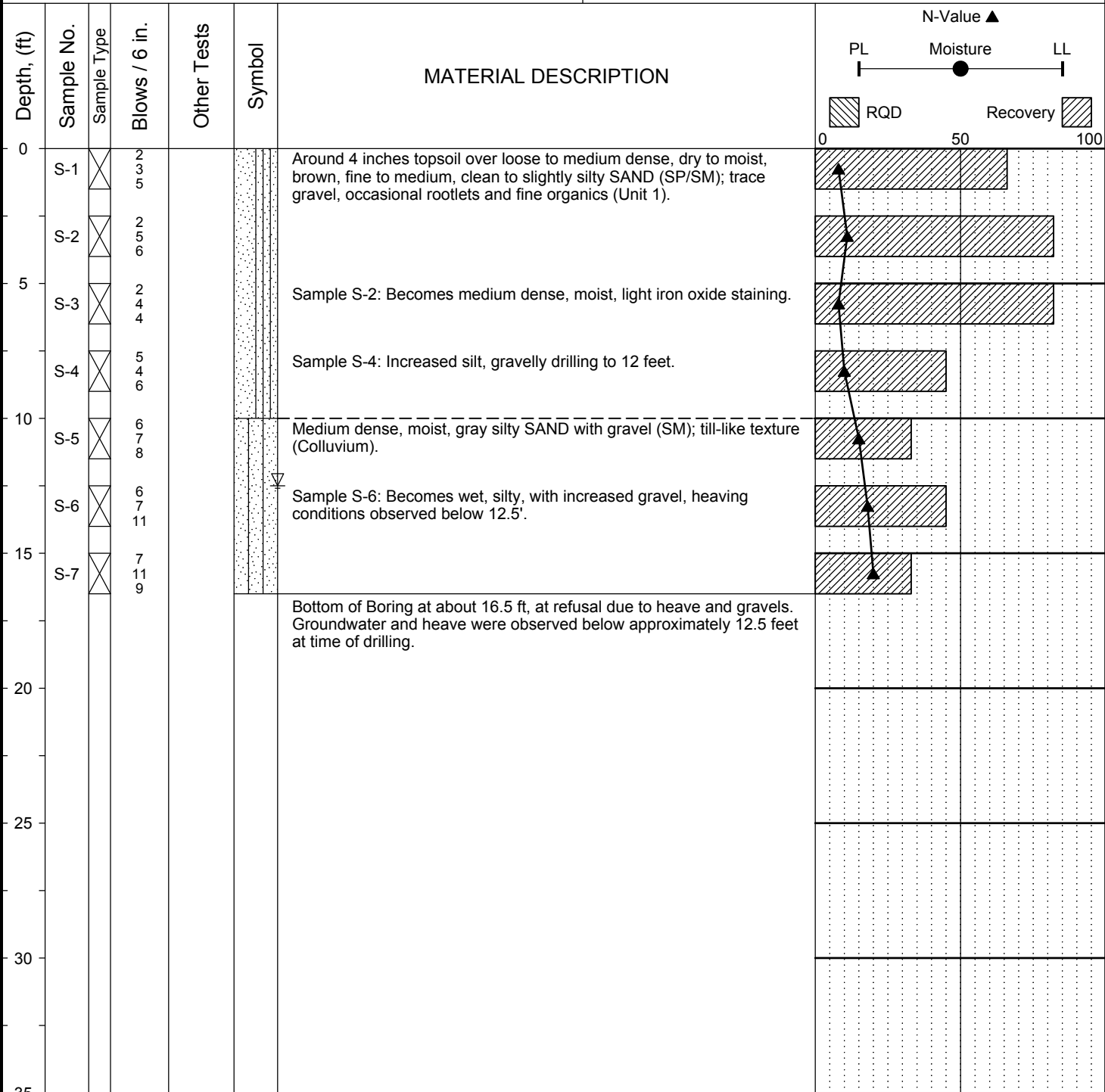

Completion Depth: 16.5ft Date Borehole Started: 8/29/14 Date Borehole Completed: 8/29/14 Logged By: NER Drilling Company: CN Drilling, Inc.	Remarks: Acker Portable Drill. Standard Penetration Test (SPT) sampler driven with a 140 lb. hammer. Hammer operated with a rope and cathead mechanism. Elevation data based on site survey by GeoDimensions, Inc.
---	--